

ring

ficha técnica

datasheet

ref. 5551663

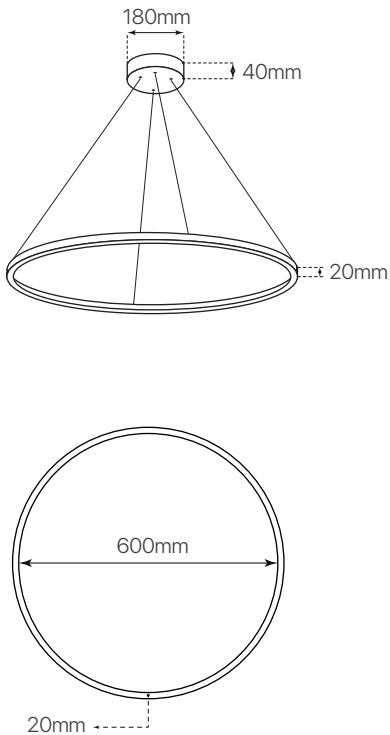

Nombre / Name	Ring
Referencia / Reference	5551663
Materiales / Materials	Aluminio + PVC / Aluminum + PVC
Difusor / Diffuser	PVC
Potencia / Power	48W
Temperatura de color / Color temperature	2700K
Flujo luminoso / Luminous flux	3516 lm
Dimable / Dimmable	No
Ángulo de apertura / Beam angle	120°
Ángulo de inclinación / Inclination angle	-
IP	20
I.K.	-
F.P. / P.F.	>0,95
UGR	<25
IRC	>80
Chip	San'an 2835
Driver	LIFUD
Vida media (duración) / Average life	30,000h
Clase energética / Energy class	A+
Aislamiento eléctrico / Electrical isolation	Clase II
Colores / Colors	Blanco
Medida exterior / Product size	600mm x 20mm
Protección contra Sobretensiones / surge protection	3,75kV
Tª (ambiente/trabajo) / Tª (environment/work)	-20°C ~ 50°C
Input	AC170 ~ 265V
Output	DC30 ~ 40V
Frecuencia / Frequency	50/60Hz
Peso / Weight	2,05kg
Certificados / Certificates	CE
Garantía / Warranty	2 años / 2 years